

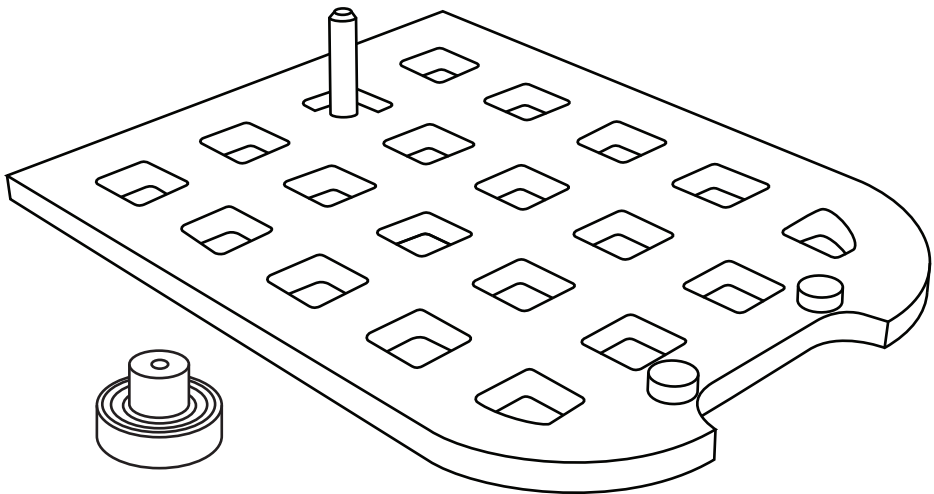

CRB7 - EDGING & DOWEL TRIM KIT



INSTRUCTION MANUAL



FREE 5 YEAR EXTENDED WARRANTY

Register Online
mpower-tools.com/warranty

CRB7 EDGING AND DOWEL TRIM KIT

Thank you for purchasing the MPOWER Edging Trim Kit. This CRB7 accessory should give lasting performance if used in accordance with these instructions.

The following symbols are used throughout these instructions.



Denotes risk of personal injury, loss of life or damage to the tool in case of non-observance of the instructions.



Refer to the instruction manual of your power tool.

INTENDED USE

The Edging Trim Kit has been designed for use with the MPOWER Combination Router Base (CRB7) to flush trim hardwood lippings and Dowels.

Edging width Max: 19/32" (15mm) with Bearing.

Edging width Max: 1" (25mm) without Bearing

Edging projection Max: 13/64" (5mm).

Router cutter diameter Max: 1" (25mm).

SAFETY

Please read and understand the safety points at the end of this instruction as well as the power tool instructions before use.

ITEMS ENCLOSED & DESCRIPTION OF PARTS

1. Riser Pad - Attaches to the CRB7 baseplate allowing suitable clearance for the router cutter to trim the edging.
- 1B. Pad Dowel - Secures the riser pad to the the CRB7 baseplate via the bridge pinchbolt hole.
- 1C. Pad Pins x 2 - Locate into the CRB7 baseplate preventing the riser pad from skewing during use.
2. Guide Bearing - Attaches to the CRB7 baseplate guiding the cutter along the edge of the workpiece.
- 2B. Slot Head Screw - Fixes the guide bearing pillar to the CRB7 baseplate.
- 2C. Pillar - Retains the bearing and acts as the axis point for the bearing.
- 2D. Hex Socket Head Screw - Fixes the bearing to the pillar.
- 2E. Washer - Holds the bearing in place allowing rotation.

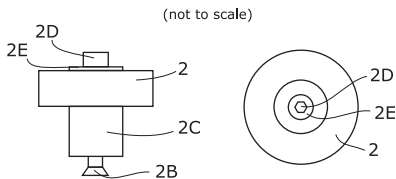
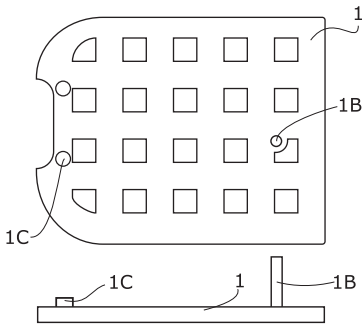

(not to scale)

ASSEMBLY

Fitting the Edging Trim Kit to the CRB7

Before use please remove protective film from the CRB7 acrylic base.

- Remove the router from the CRB7 and place to one side.
- Loosen the CRB7's bridge pinchbolt.



Remove the offset handle or anti-tilt leg if they are fitted in the bridge.

- Fit the guide bearing assembly to the underside of the CRB7 baseplate via the countersunk hole (F) using the slot head screw (2B)

If the edging exceeds 15mm (width) the guide bearing assembly (2) will not be required.

- Once the guide bearing assembly is fitted into position place the riser pad (1) onto a flat surface so the guide bearing (2) hangs over the edge allowing the riser pad (1) to sit flat on the surface.
- Align the CRB7 baseplate over the riser pad (1) so that the pad dowel (1B) locates directly into the bridge pinchbolt hole (H) and the pad pins (1C) locate into the baseplate letterbox.
- Then gently lower the CRB7 onto the riser pad (1) and press down until the riser pad is secure.
- Once in place tighten the bridge pinchbolt against the pad dowel (1B) to secure riser pad (1) firmly in position.
- The CRB7 and Edging Trim Kit are now ready for use

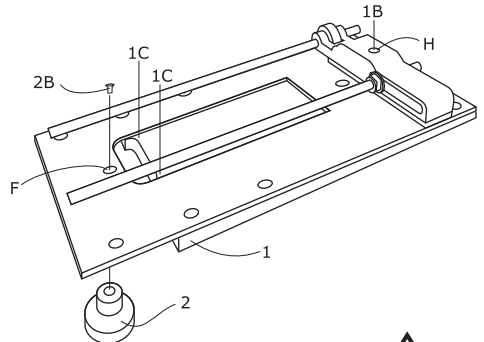

Hardwood & Iron-on Edging Trim Instructions

The CRB7 fitted with the Edging Trim Kit is a fast and accurate method of consistently trimming solid hardwood and iron on edging flush with its core panel.

Positioning of the Router Cutter

- Fit the edge trimming kit to the CRB7 as detailed above.
- Slide the router onto the CRB7 guide rods and butt the router up against the bridge.
- Position the CRB7 baseplate so that the guide bearing (2) overhangs the workpiece and butts up against the workpiece edging (J).

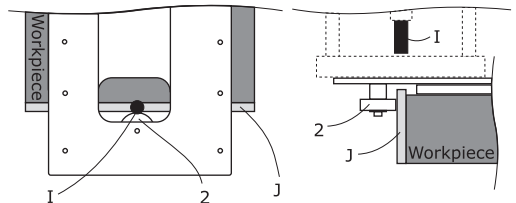

- Slide the router forward so that the router cutter (I) can safely pass through the CRB7 riser pad (1) letterbox and position the router cutter (I) directly over the edging (J) to be routed.
- Lock the router pinch bolt on the CRB7's adjuster rod and micro adjust if required.

⚠ Always isolate router from power supply before making any adjustments.

OPERATION

Setting the Router Cutter Depth

Setting the depth of the router cutter should be carried out on a separate work surface to avoid damaging your work piece.

- Take the CRB7 router assembly and position onto a flat surface with the guide bearing (2) butted against the edge.
- Lower the router cutter (I) so that the cutter tip just makes contact with the surface and lock the router cutter (I) height in.
- Test the router cutter (I) depth by sliding the CRB7 router assembly over a flat waste board. The router cutter (I) should just make a slight mark - but not actually remove any material from the surface of the waste board.

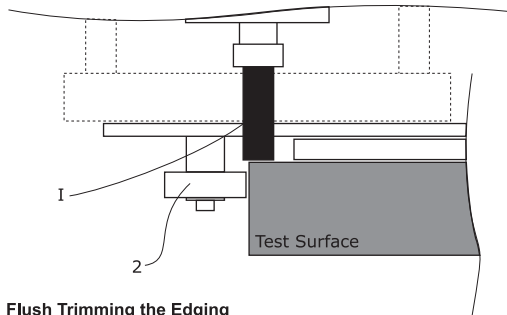

Flush Trimming the Edging

- Return the CRB7 router assembly so that it's resting on the end of the workpiece.
- Plug the router into the power supply.
- Turn the router on and feed the CRB7 router assembly along the length of the edging (J), ensure the guide bearing (2) remains in contact with the board edge at all times.
- The edging (J) should now be flush with the workpiece surface. At the end of the router pass, turn off the router.

⚠ If the Edging (width) exceeds 15mm. Remove the Guide Bearing assembly (2) and take multiple routing passes. The first pass should start slightly over-lapping the workpiece. Subsequent passes should then work away toward the outside edge of the lipping.

- After use remove accessory and store carefully.

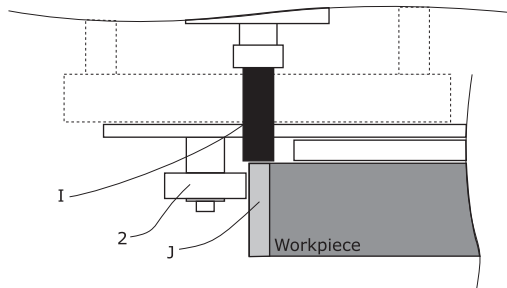

MAINTENANCE

Please use only MPOWER original spare parts. Continual satisfactory operation depends upon proper tool care and regular cleaning.

Cleaning:

Regularly clean accessory with a soft cloth.

Lubrication:

Your accessory requires no additional lubrication.

Storage:

Return accessory to its packaging after use.

ENVIRONMENTAL PROTECTION

Recycle raw materials instead of disposing as waste.

Packaging should be sorted for environmental-friendly recycling. This product and its accessories at the end of its life should be sorted for environmental-friendly recycling.

GUARANTEE

All MPOWER products are guaranteed against any defects in either workmanship or material, except products that have been damaged due to improper use or maintenance.

Safety Points

1. Disconnect power tool and attachment from power supply when not in use, before servicing, when making adjustments and when changing accessories such as cutters. Ensure switch is in "off" position. Always ensure cutter has stopped rotating.
2. Read and understand instructions supplied with power tool, attachment and cutter.
3. Current Personal Protective Equipment (PPE) for eye, ear and respiratory protection must be worn. Keep hands, hair and clothes clear of the cutter.
4. Before each use check cutter is sharp and free from damage. Do not use if cutter is dull, broken or cracked or if any damage is noticeable or suspected.
5. The maximum speed (nmax) marked on tool or in instructions or on packaging shall not be exceeded. Where stated, the speed range should be adhered to.
6. Insert the shank into the router collet at least all the way to the marked line indicated on the shank. This ensures at least 3/4 of shank length is held in collet. Ensure clamping surfaces are clean.
7. Check all fixing and fastening nuts, bolts and screws on power tool, attachment and cutting tools are correctly assembled, tight and to correct torque setting before use.
8. Ensure all visors, guards and dust extraction is fitted.
9. The direction of routing must always be opposite to the cutter's direction of rotation.
10. Do not switch power tool on with the cutter touching the workpiece.
11. Trial cuts should be made in waste material before starting any project.
12. Repair of tools is only allowed according to tool manufacturers instructions.
13. Do not take deep cuts in one pass; take several shallow passes to reduce the side load applied to the cutter.

Our policy of continuous improvement means that specifications may change without notice. MPOWER Tools Limited cannot be held liable for any material rendered unusable, or for any form of consequential loss.



Manufactured by MPOWER Tools Ltd

Tel: 0044 (0)1980 629 526

Email: technical@m-powertools.com

Email: customercare@m-powertools.com

Web: www.m-powertools.com

Manor Farm Reserve - Newton Tony - Salisbury - Wiltshire - SP4 0HA - UK

© Copyright MPOWER Tools Ltd 2020